

User manual

CLIMATIC™ 40



- Providing indoor climate comfort



CONTENTS	PAGE
• INDEX	1
• DESCRIPTION OF CONTROLS	2-3
1.- CLIMATIC 40 CONTROL	4-6
2.- DC40 REMOTE TERMINAL (AIRCOOLAIR)	7-8
• MENU	
• REGULATION	9
1.- AIRCOOLAIR /COMPACTAIR / FLATAIR	9
2.- AIRCUBE	
• ADVANCED FUNCTIONS	10
1.- REMOTE ON/OFF	10
2.- REMOTE WINTER / SUMMER CHANGEOVER	10
3.- DYNAMIC SET POINT	11-13
4.- BMS COMUNICATIONS	14
5.- LOW NOISE	14
6.- ANALOGUE / DIGITAL INPUT	15
7.- TIMING AND DELAYS	16
8.- DEFROST	16-17
9.- CONDENSER FAN SPEED CONTROL	17-18
10.- FREE COOLING	19
• PARAMETERS	20-22
• SAFETY DEVICES	23
• INSTRUCTIONS FOR ASSEMBLY AND INSTALLATION	24
• ALARMS	25-28

DESCRIPTION OF CONTROLS

1.- CLIMATIC 40 CONTROL

Climatic 40 control, is an electronic device that controls Aircoolair / Compactari / Flatair units (air-air units) and Aircube units (condensing units).

The thermostat allows the following operations:

- Unit ON/OFF.
- Select system operating mode.
- Set point adjustment.
- Alarm signal relay.
- Display temperature, status of unit and pending alarms.
- Programming of time bands.
- BMS communications.
- Possibility of remote ON/OFF.

AIRCOOLAIR / COMPACTAIR / FLATAIR

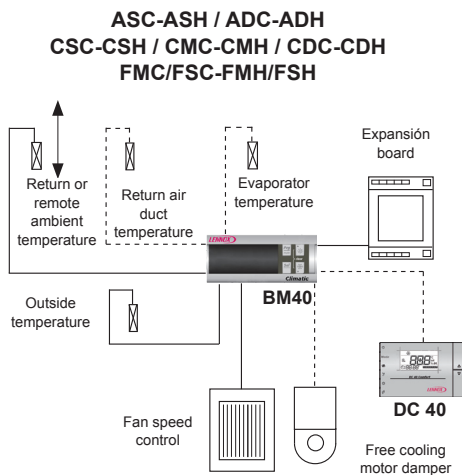

AIRCUBE

KSCM/KSHM

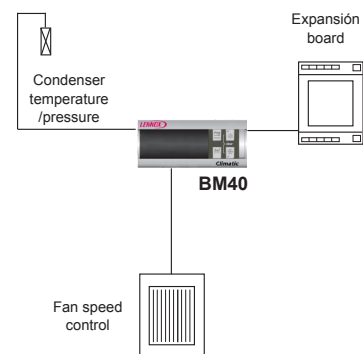

Return / remote ambient, evaporator, temperature/pressure condenser and outdoor temperature probes.

Proportional regulation based on remote ambient /return temperature (cooling, heating and automatic mode).

Defrost cycle (heat pump units), with pressure transducer.

Condensing pressure control with temperature probe or pressure transducer.

Antifreeze, high and low pressure protections.

Compressors, indoor and outdoor fans, electrical heater and freecooling (optional) management.

Condenser temperature/pressure probes.

Regulation based on remote free voltage contacts.

Defrost cycle (heat pump units), with pressure transducer.

Condensing pressure control with temperature probe or pressure transducer.

High and low pressure protections.

Compressors, indoor (optional) and outdoor fans.

DESCRIPTION OF CONTROLS

CLIMATIC 40 CONTROL

The figure and the table below show the symbols present on the display and on the keypad, together with their meanings:

The main screen shows:

- Ambient temperature for AIRCOOLAIR / COMPACTAIR / FLATAIR.
- Unit status (On/Off) for AIRCUBE.

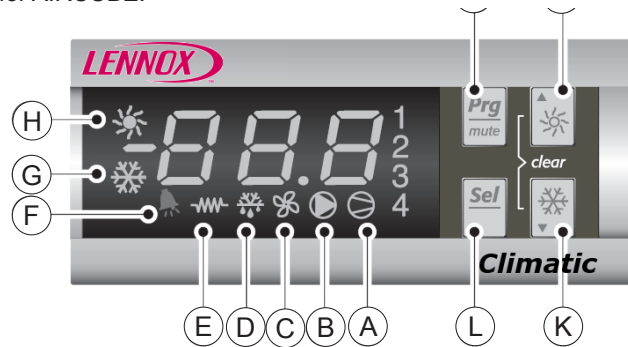

SYMBOL	DESCRIPTION	
	LED ON	LED FLASHING
1 or 2	Compressor 1 and /or 2 (circuit 1) ON.	Start up request.
2 or 3	Compressor 3 and /or 4 (circuit 2) ON.	Start up request.
A	At least 1 compressor ON.	
B	Indoor fan ON.	Start up request.
C	Condenser fan ON.	
D	Defrost active.	Start up request.
E	Electrical heater ON.	Start up request.
F	Alarm active.	
G	Cooling mode.	Cooling mode request.
H	Heat pump mode.	Heat pump mode. Request.

BUTTON	DESCRIPTION	TIME
I	Go up a sub-group inside the programming area.	Press once
L	Access the direct parameters.	Press for 5 s
	Select item inside the programming area / confirm changes to the parameters.	Press once
I+L	Program parameters after entering password.	Press for 5 s
J	Select top item inside the programming area.	Press once
	Increase value.	Press once
	Switch from standby to heat pump mode and vice-versa.	Press for 5 s
K	Provides immediate access to the condenser and evaporator pressure and temperature probes.	Press once
	Select bottom item inside the programming area.	Press once
	Decrease value.	Press once
	Switch from stand-by to chiller mode and vice-versa.	Press for 5 s
J+K	Provides immediate access to the condenser and evaporator pressure and temperature probes.	Press once
	Manual alarm reset.	Press for 5 s
L+J	Immediately reset the hour counter (inside the programming area).	Press for 5 s
	Force manual defrost on both circuits.	Press for 5 s

1.1.- AIRCUBE

1.1.1.- TURN ON/OFF THE UNIT

The unit is turned on by closing the On/Off contact and turned off by opening it (see section 1, *advanced functions*, for more details).

The heating mode is selected by opening the remote changeover contact while the cooling mode is selected by closing it (see section 2, *advanced functions*, for more details).

NOTE

There are no set points to be made for Aircube units because the compressors are directly controlled by remote contacts.

DESCRIPTION OF CONTROLS

2.- DC40 REMOTE TERMINAL (AIRCOOLAIR / COMPACTAIR / FLATAIR)

The illustration and the table below show the symbols that appear on the display and on the keypad and their meanings. OFF appears in the main field of the display if the machine is off. or the set point if the machine is working.

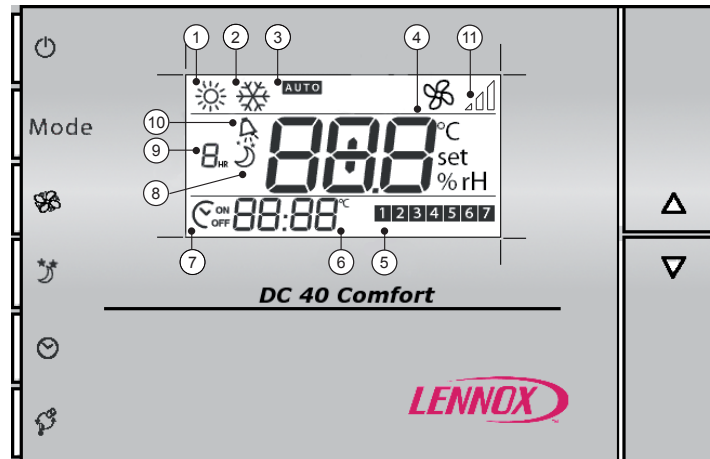

BUTTON	NAME	DESCRIPTION
	POWER	Switch from stand-by to ON and vice-versa.
Mode	MODE	Change operating mode (cooling, heating, automatic).
	FAN	Switch the indoor fan from automatic mode to always ON and vice-versa.
	SLEEP	ActivateS/deactivateS the sleep mode.
	CLOCK	ActivateS/deactivateS the time bands.
	TEMP.	ShowS the set point when the unit is OFF.
	UP/DOWN	Set the temperature.

Secondary functions:

BUTTON	BUTTON PRESS	FUNCTION
	3 seconds	Sets sleep differential value of the current operating mode.
	3 seconds	Sets the time bands (hour, day, set point).
	5 seconds	Clock setting.
	3 seconds	Reset alarms.

Display symbols:

SYMBOL	MEANING	SYMBOL	MEANING
1	Heating mode.	7	On/Off time bands.
2	Cooling mode.	8	Sleep mode.
3	Automatic mode.	9	Duration or sleep mode.
4	Set point.	10	Alarm.
5	Day of the week (weekday, weekend).	11	Indoor fan mode.
6	Hour/Temperature.		

DESCRIPTION OF CONTROLS

2.1.- TURN ON/OFF THE UNIT WITH REMOTE CONTROL DC40 (AIRCOOLAIR / COMPACTAIR / FLATAIR)

To **turn on** the unit press the “” button.

The display shows current operating mode.

2.2.- SELECTING THE UNIT'S OPERATING MODE

Once the unit is turned on, you can select Cooling, Heating or Automatic mode just pressing the “**Mode**” button. In the automatic mode you just choose the set point and the system automatically switches from cooling to heating mode, depending on the position of the ambient temperature with respect to the set point.

2.3.- SELECTING DESIRED ROOM TEMPERATURE

If unit is working, the “ 

The “

The “

2.4.- SELECTING THE FAN OPERATING MODE (Aircoolair)

In order to be able to select a fan operating mode, the unit's operating mode (cooling, heating or auto) must be selected.

Pressing the side button “

FAN CONSTANTLY ON: Fan is ON continuously and the “

AUTO: Fan on and off together with the compressor or with the freecooling, the “

NOTE: For units without remote control DC40, fan operating mode can be selected with parameter H05=1 (continuous operating mode) or H05=2 (automatic operating mode).

2.5.- SLEEP FUNCTION

This function increases (in cooling mode) or decreases (in heating mode) the operating set point according to the lower level of comfort required during the night.

Not possible with time bands program.

ACTIVATION

Press “

In this way, sleep function will work for 1 hour.

If you want it to work for longer, press “

Finally, the display shows the “

DEACTIVATION

Press the “

DIFFERENTIAL SETTINGS

Press “

Use the “

Note that cooling and heating modes have different sleep differential values, so you can modify only the current operating mode's value.

2.6.- CLOCK SETTINGS

To set current time:

1. Press the “

2. Set the hour using the “

3. Press the “

4. Set the minutes using the “

5. Press the “

6. Set the day by using the “

7. Press the “

2.7.- TIME BANDS PROGRAM

This function allows you to programme time bands during the week, each one with a different set point. In this way you can adapt the cooling/heating provided by the unit according to each moment of the day.

You can set two time bands for the weekdays and another two for the weekend.

DESCRIPTION OF CONTROLS

CONFIGURATION

a) Enter time bands menu.

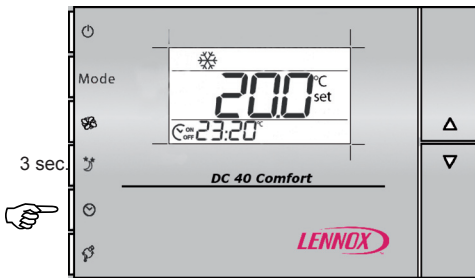

b) Set 1ST time band for weekday start hour.

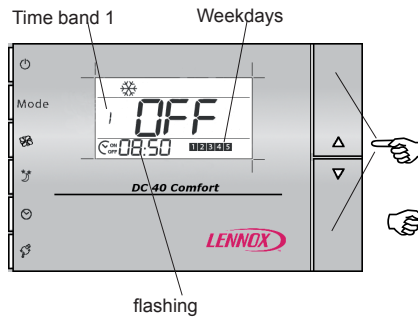

c) Accept.



d) Set 1ST time band of weekday start minutes.

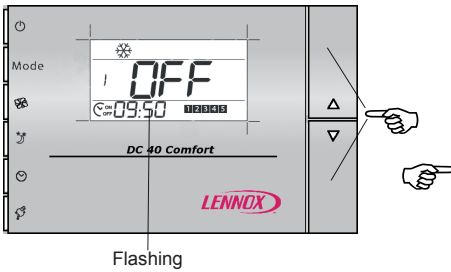

e) Accept.



f) Set 1ST time band of weekday set point (on/off/temperature).

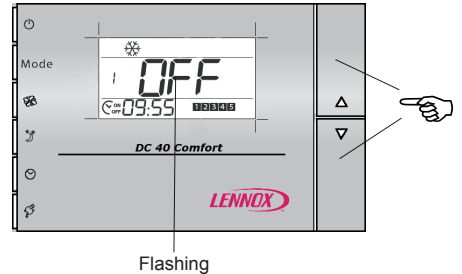

g) Accept.

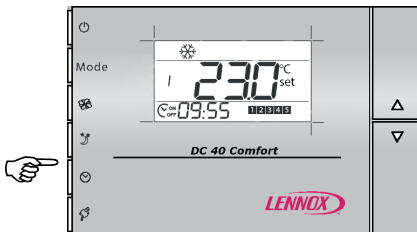

h) Repeat steps b-c-d-e-f-g to programme 2nd time band for weekdays.

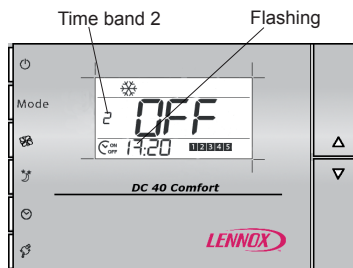

i) Repeat steps b-c-d-e-f-g-h to programme the two time bands for weekends.

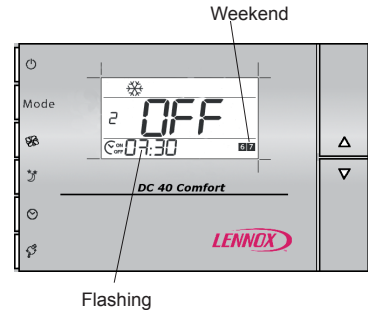

ACTIVATION

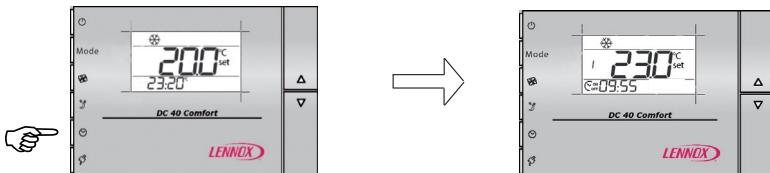

DEACTIVATION

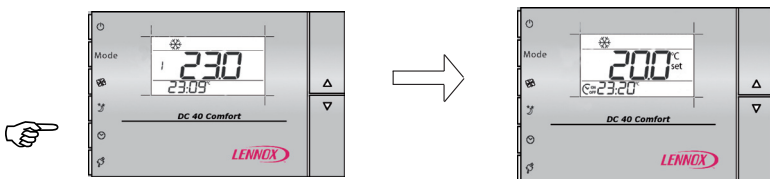

EXAMPLE IN SUMMER

Hour	Weekdays	Weekend
8:00 (Time band 1)	23°C	OFF
18:00 (Time band 2)	23°C	OFF

NOTE: You must set the DC40 clock before programming time bands.

Time bands programs keep current operating mode (if it was in cool mode, it keeps working in cool mode; if it was in auto matic mode, it keeps working in automatic mode, etc.).

MENU

Access to the menu:

A) PROBES DISPLAY MENU

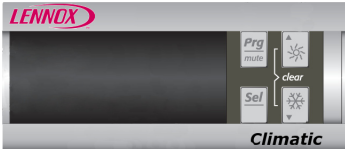

1 sec. Press the “” button to enter probes display menu.

“b01” or “b02”, appears on the display (depending on the unit's configuration).

Once the probe is selected, after a few seconds, “b01” turns into its temperature/pressure measure.

B) SETPOINT SETTINGS AND OPERATING HOURS DISPLAY MENU



5 sec.

Press “Sel” button for 5 seconds.

“—┐—”, appears on the display.

Move inside the menu as explained below.

C) PARAMETERS EDITING MENU

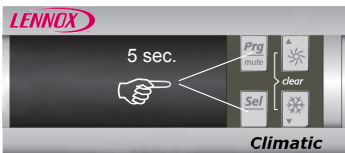

5 sec.

a) Press “Pgr” and “Sel”, at the same time, for 5 seconds.



b) Set password “22” by the “” and “” buttons.



c) Press “Sel”, to accept.



d) Press “Sel”, to enter parameters Editing menu.

To go to different values in the menu, proceed as above, the:

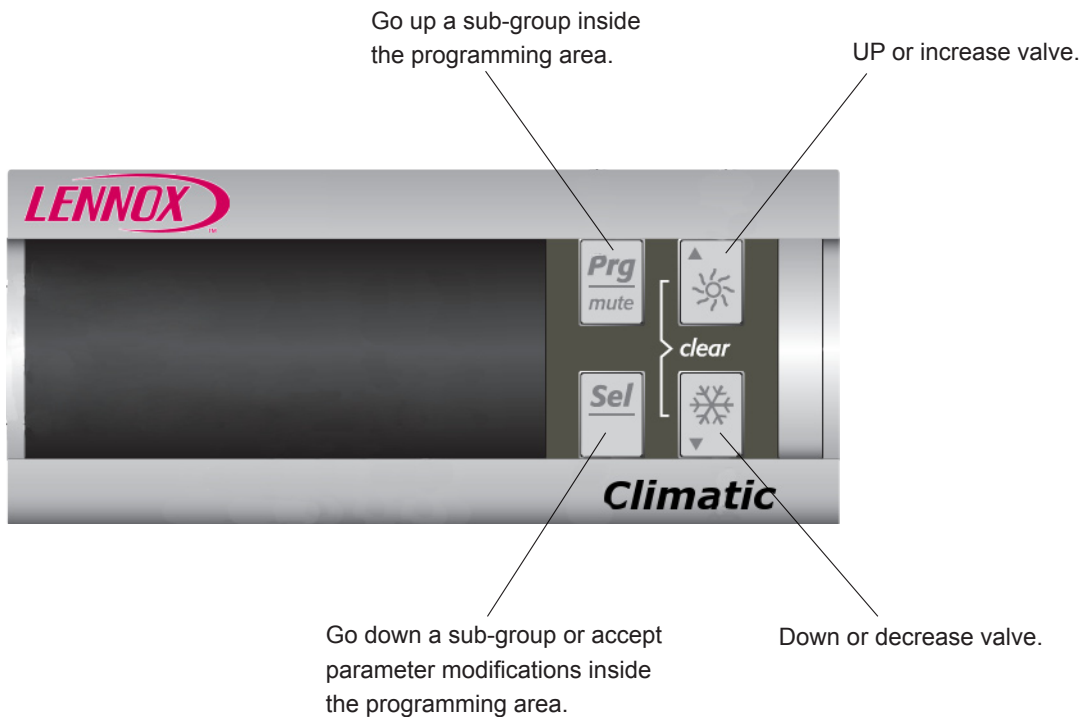

MENU

MENU TREE

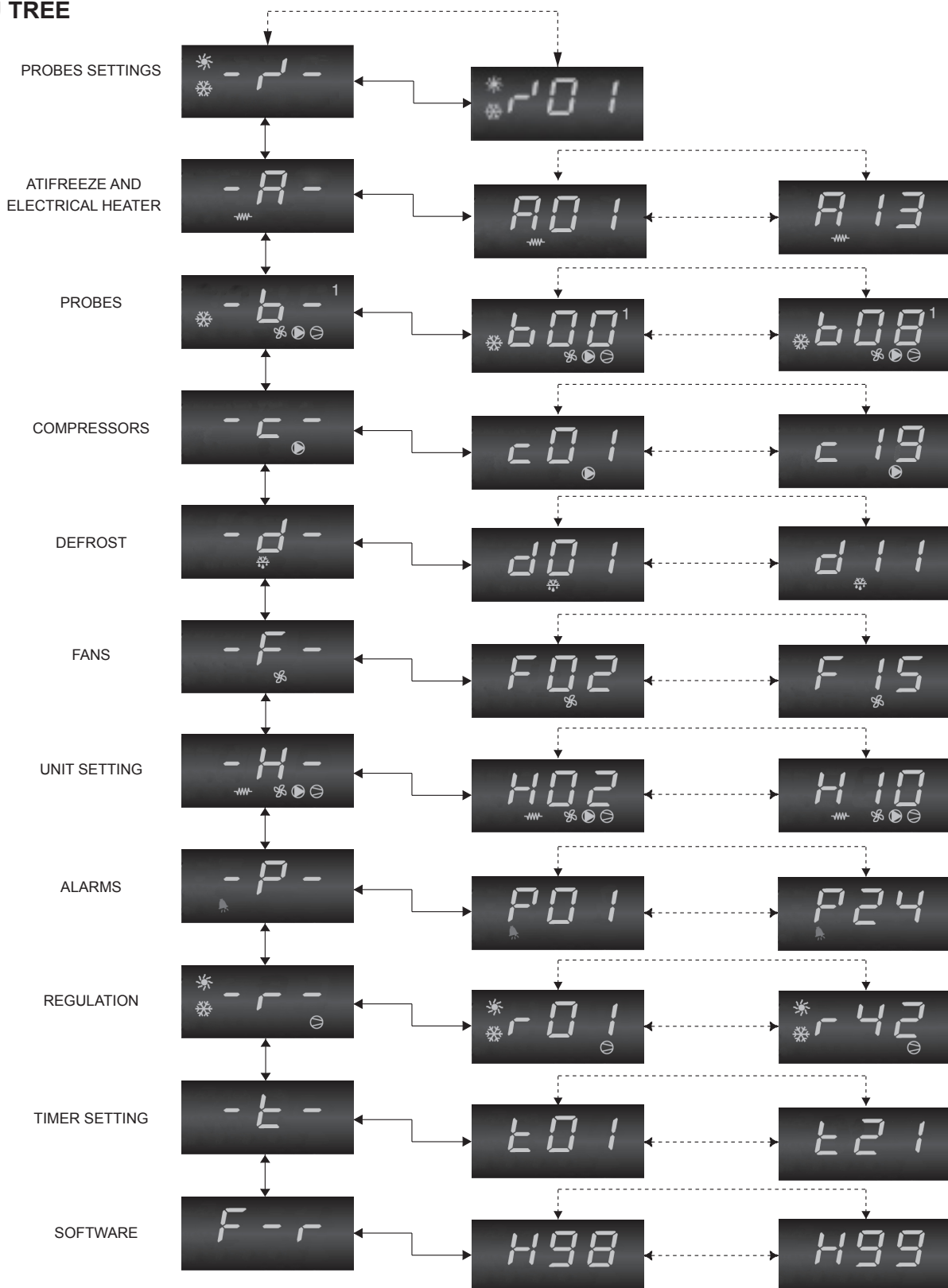

NOTES:

- Parameters that have been modified without being confirmed using the “Sel” button will return to their previous value.
- After confirming a modification, escape up to the main menu to save it; otherwise, modifications will be cancelled.
- If no operations are performed on the keypad for 60 seconds, the controller exits the parameter editing menu on timeout and any changes are cancelled.

REGULATION

1.- AIRCOOLAIR / COMPACTAIR / FLATAIR

Ambient (or return air duct) temperature is thermostatically controlled via set point and tolerance range (differential) as shown in the following diagrams:

1.1- AUTOMATIC MODE (with DC40) (Heat pump)

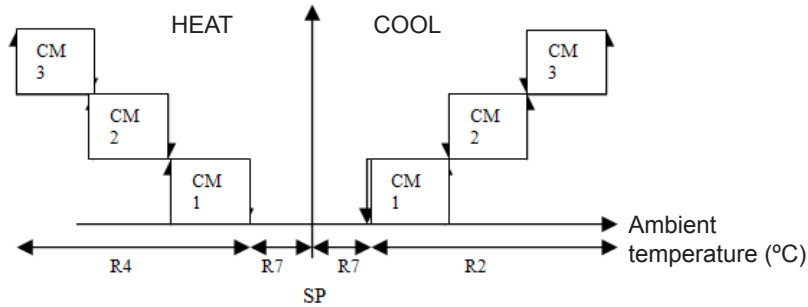

1.2- AUTOMATIC MODE (Cooling only+Electrical heater)

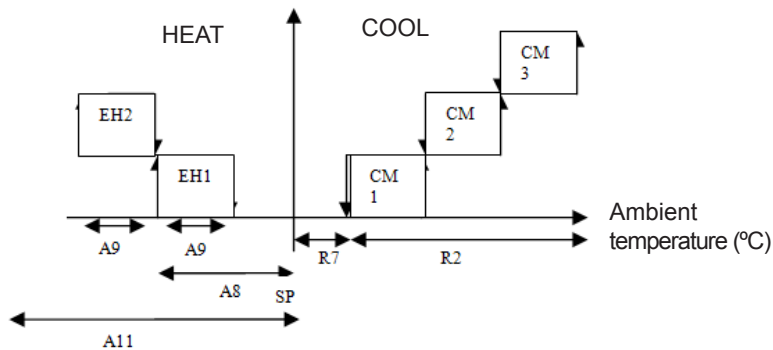

NOTE: With option Modbus, set point SP is managed through communications instead of DC40 (see table for Modbus parameters)

1.3- AFFECTED PARAMETERS

Par.	DESCRIPTION	UNIT 1 COMPRESSOR			UNIT 2 COMPRESSORS			UNIT 3 COMPRESSORS		
		MIN.	MAX.	DEF.	MIN.	MAX.	DEF.	MIN.	MAX.	DEF.
SP	Set point (DC40).	8	32	23	8	32	23	8	32	23
r2	Cooling differential.	0.3	50	1	0.3	50	2	0.3	50	3
r4	Heating differential.	0.3	50	1	0.3	50	2	0.3	50	3
r7	Dead zone.	0.3	50	0.5	0.3	50	0.5	0.3	50	0.5
A8	SP E.H. 1 stage (cooling only/heat pump)	0	20	1.5/2.5	0	20	1.5/3.5	0	20	1.5/4.5
A9	Differential E.H.	0.3	50	1	0.3	50	1	0.3	50	1
A11	SP E.H. 2 stages (cooling only/heat pump)	0	20	2.5/3.5	0	20	2.5/4.5	0	20	4.5

2.- AIRCUBE

Aircube is regulated by digital input. (see section 7, *advanced functions*, for more details).

ADVANCED FUNCTIONS

1.- REMOTE ON/OFF

This function allows you to turn the unit on/off by a simply remote contact (contacts 95-96 in AIRCOOLAIR /COMPACTAIR / FLATAIR units;contacts 88-89 in AIRCUBE units).

Close contact = ON; Open contact = OFF.

2.- REMOTE CHANGEOVER WINTER/SUMMER

On heat pump units (also in Aircoolair / Compactair / Flatair cooling only + electrical heater), cooling or heating mode can be selected by a remote contact (contacts 97-98 in Aircoolair and contacts 95-98 in Compactair and Flatair).

Close contact = Cooling.; Open contact = Heating.

To activate this function set parameters **P09=10** and **H06=1**.



WARNING

On Aircoolair units, remote changeover doesn't work if the automatic mode has been selected by DC40.

3.- DYNAMIC SET POINT

It is possible a better unit operating mode through dynamic set point function.

With this function the set point can be changed, (going up/down) according to the external conditions in order to save energy.

To activate this function, the custome should configurate the parameters explained in the picture below:

*To activate P09 use password 66.

AIRCOOLAIR / COMPACTAIR / FLATAIR

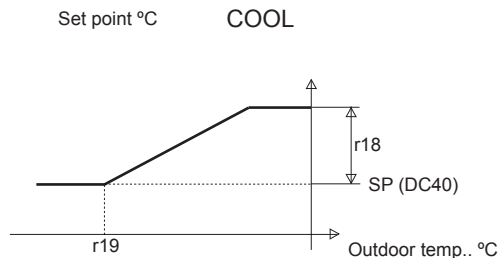

$$SP = SP(DC40) + (T.ext. - r19) \times r17$$

EXAMPLE

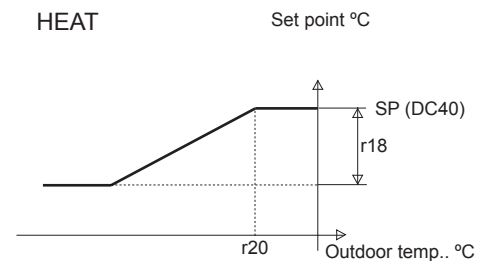
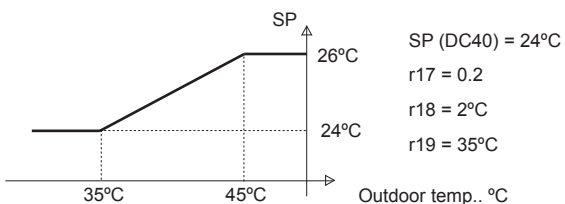

$$SP = SP(DC40) + (T.ext. - r20) \times r31$$

EXAMPLE

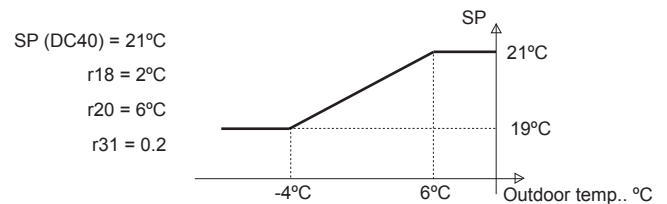

ADVANCED FUNCTIONS

4.- BMS COMMUNICATIONS

OPTION

BMS (Building Management Systems) are systems to integrate all technological functions of a building, including access control, security, detection of fires, lights, elevators and air conditioning.

Given the growing and unstoppable trend towards Building Automation, the Climatic 40 controller offers the possibility of communicating with Building Management Systems (BMS) via Modbus protocol. The Modbus standard interface is integrated into the control, so you do not need any sort of gateway, router, etc.

LENNOX units with Modbus protocol use parametrization below:

Serial port	RS485 (EIA/ TIA-485 standard)
Transmission mode	RTU (Terminal of remote unit)
Speed	9600 Baudios
Bits of data	8 bits
Parity	None
Stop bits	2 bit
Addresses	Base 0

4.1 – MODBUS NET CONFIGURATION

With option Modbus communication, Climatic 40 controller is delivered configured and ready for communications. The only parameter which is needed to adjust is the device address (**H10**).

Without option Modbus communication change parameters H23=1 and H24=0 to enable the option.

Connect the net like in figure below:

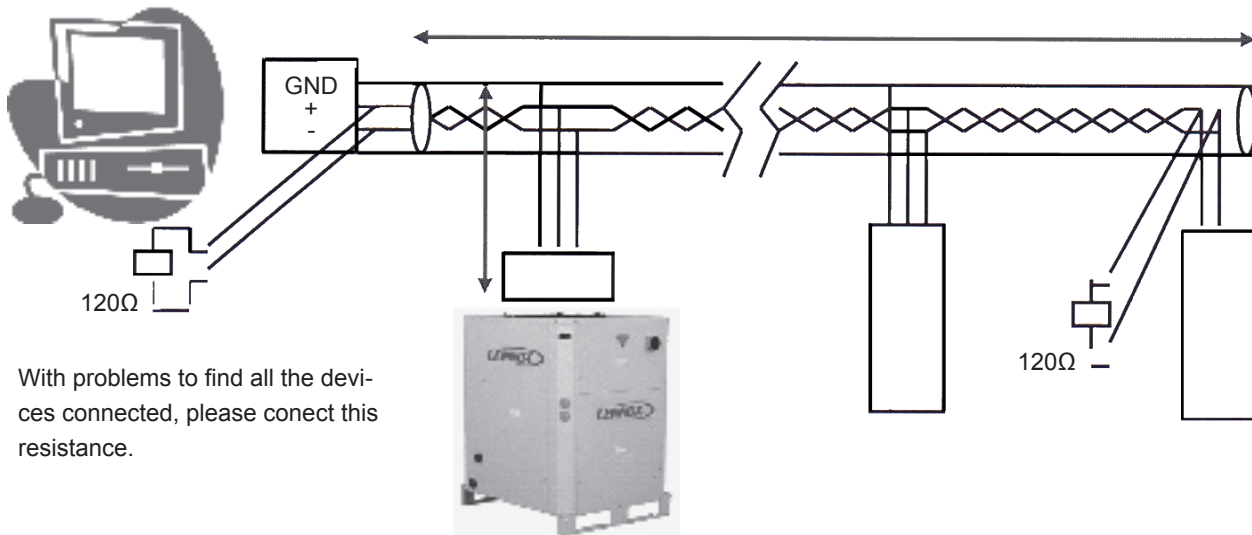

With problems to find all the devices connected, please connect this resistance.



- Right connection order in the electrical box for LENNOX units should be respected 90= GND ; 91= + ; 92= —.
- According to the electromagnetic compatibility standard, it is needed to use a pair of specific shielded cables for data transmission with RS485.
- With several units connected into the same Modbus net, secondary of the transformer has not to be earthed for each unit.

ADVANCED FUNCTIONS

4.2 - PARAMETERS TABLE

U.O.M.= Measurement unit

Resol. = Solution

R/W = Reading/ Writing

Parameters and description	min.	máx.	U.O.M.	resol.	R/W	Modbus address	Type of variable
ALARMS							
Circuit 1 alarm	0	1	Flag	1	R	41	Digital
Circuit 2 alarm	0	1	Flag	1	R	42	Digital
Indoor fan alarm/ Water pump alarm	0	1	Flag	1	R	45	Digital
Alarm sensor	0	1	Flag	1	R	46	Digital
Alarm reset	0	1	Flag	1	R/W	78	Digital
INPUTS AND OUTPUTS							
Digital input 1	0	1	Flag	1	R	53	Digital
Digital input 2	0	1	Flag	1	R	54	Digital
Digital input 3	0	1	Flag	1	R	55	Digital
Digital input 4	0	1	Flag	1	R	56	Digital
Digital input 5	0	1	Flag	1	R	57	Digital
Digital output 1	0	1	Flag	1	R	59	Digital
Digital output 2	0	1	Flag	1	R	60	Digital
Digital output 3	0	1	Flag	1	R	61	Digital
Digital output 4	0	1	Flag	1	R	62	Digital
Digital output 5	0	1	Flag	1	R	63	Digital
Digital input 6	0	1	Flag	1	R	66	Digital
Digital input 7	0	1	Flag	1	R	67	Digital
Digital input 8	0	1	Flag	1	R	68	Digital
Digital input 9	0	1	Flag	1	R	69	Digital
Digital input 10	0	1	Flag	1	R	70	Digital
Digital output 6	0	1	Flag	1	R	72	Digital
Digital output 7	0	1	Flag	1	R	73	Digital
Digital output 8	0	1	Flag	1	R	74	Digital
Digital output 9	0	1	Flag	1	R	75	Digital
Digital output 10	0	1	Flag	1	R	76	Digital
SENSORS							
Sensor value B1	- / 400	800	°C	0,1	R	102	Analogic
Sensor value B2	- / 400	800	°C	0,1	R	103	Analogic
Sensor value B3	- / 400	800	°C / Dbar	0,1	R	104	Analogic
Sensor value B4	- / 400	800	°C	0,1	R	105	Analogic
Sensor value B5	- / 400	800	°C	0,1	R	106	Analogic
Sensor value B6	- / 400	800	°C	0,1	R	107	Analogic
Sensor value B7	- / 400	800	°C	0,1	R	108	Analogic
Sensor value B8	- / 400	800	°C / Dbar	0,1	R	109	Analogic
Sensor value DC40	- / 400	800	°C	0,1	R	128	Analogic

ADVANCED FUNCTIONS

4.2 - PARAMETERS TABLE.

Parameters and description	min.	máx.	U.O.M.	resol.	R/W	Modbus address	Type of variable
UNIT CONTROL							
Unit status (1=ON ó 0=standby)	0	1	Flag	1	R/W	64	Digital
Status auto /manual (0=Manual ó 1=Automatic)	0	8	Flag	1	R/W	291	Analog
Status cooling / heating (1=Cooling or 0=Heating) (Writting is possible only with auto/manual = 0 manual)	0	1	Flag	1	R/W	65	Digital
CL40 cooling setpoint (with auto/manual = 0 manual)	*	*	°C	0.1	R/W	41	Analog
CL40 heating setpoint (with auto/manual = 0 manual)	*	*	°C	0.1	R/W	43	Analog
CL40 Auto setpoint (with auto/manual = 1 auto)	*	*	°C	0.1	R/W	61	Analog
CL40 Second cooling setpoint	*	*	°C	0.1	R/W	55	Analog
CL40 Second heating setpoint	*	*	°C	0.1	R/W	56	Analog
Fan indoor operation mode 1 = always ON 2 = Automatic 3 = Anti-stratification WARNING: Do not change this value into 0, otherwise fan will be deactivated	0	5	Flag	1	R/W	263	Analog
Defrost status 0= Without defrost cycle 1= Defrost cycle 1 2= Defrost cycle circuit 2 3= Defrost cycle 1 y 2 5= Fan in defrost cycle circ.1 10= Fan in defrost cycle. circ.2 15= Fan in defrost cycle circ.1 and 2	0	255	Flag	1	R	341	Analog
Low noise activation 0= disabled 1= enable in cooling 2= enable in heating 3= enable in cooling and heating	0	3	Flag	1	R/W	292	Analog
Minimum configuration of fresh air 0= disabled 1= with freecooling enable 6= with freecooling disabled 7= always 8= cooling mode 9= heating mode	0	9	Flag	1	R/W	326	Analog
Minimum fresh air %	0	100	%	1	R/W	327	Analog
CLOCK CONFIGURATION							
Real time : hours	0	23	h	1	R/W	336	Analog
Real time : minutes	0	59	min	1	R/W	337	Analog
Real time: day	0	31	día	1	R/W	338	Analog
Real time : month	0	12	mes	1	R/W	339	Analog
Real time: year	0	99	año	1	R/W	340	Analog
Start hours for 2nd set point in cooling	0	23	h	1	R/W	299	Analog
Start minutes for 2nd set point in cooling	0	59	min	1	R/W	300	Analog
End hours for 2nd set point in cooling	0	23	h	1	R/W	301	Analog
End minutes for 2nd set point in cooling	0	59	min	1	R/W	302	Analog
Start houts for 2nd set point in heating	0	23	h	1	R/W	303	Analog
Start minutes for 2nd set point in heating	0	59	min	1	R/W	304	Analog
End hours for 2nd set point in heating	0	23	h	1	R/W	305	Analog
End minutes for 2nd set point in heating	0	59	min	1	R/W	306	Analog
Start hours for 2nd set point low noise cooling	0	23	h	1	R/W	307	Analog
Start minutes for 2nd set point low noise cooling	0	59	min	1	R/W	308	Analog
End hours for 2nd set point low noise cooling	0	23	h	1	R/W	309	Analog
End minutes for 2nd set point low noise cooling	0	59	min	1	R/W	310	Analog
Start hours for 2nd set point low noise heating	0	23	h	1	R/W	311	Analog
Start minutes for 2nd set point low noise heating	0	59	min	1	R/W	312	Analog
End hours for 2nd set point low noise heating	0	23	h	1	R/W	313	Analog
End minutes for 2nd set point low noise heating	0	59	min	1	R/W	314	Analog

ADVANCED FUNCTIONS

5.- LOW NOISE

Available for models with proportional fan pressure regulation.

It moves the condensing pressure set point in order to lower the fan speed and thus reduce noise (specifically at night). If low noise is active during cooling, the condenser control set points are increased by 5° bar. If low noise is active in heating, the set points are reduced by 1° bar.

Set **F15=3** to active this function.

Also set the following parameters:

COOLING			HEATING		
TIME		FAN	TIME		FAN
Rest of day		Standard	Rest of day		Standard
Start	(hour:minutes) t14:t15	LOW NOISE	Start	(hour:minutes) t18:t19	LOW NOISE
End	(hour:minutes) t16:t17		End	(hour:minutes) t20:t21	

Low noise cooling mode shift is illustrated in the following picture.

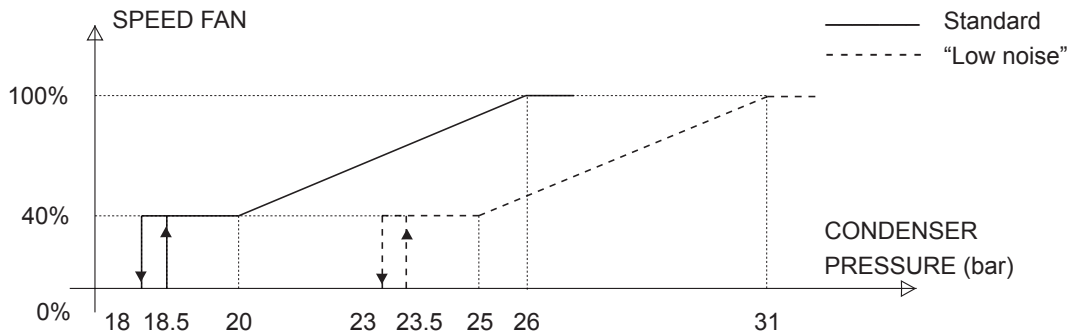

BM40: \square =1; B00=0; R23=1;

DC40: En05=1

Programming mode:

Press \leftarrow and then \blacktriangle during seconds to select the value. Press continuously \leftarrow to confirm and leave programming mode.

programación

7.- ANALOGIC / DIGITAL INPUT

PROBES	AIRCOOLAIR				COMPACTAIR				AIRCUBE				FLATAIR 2	
	20...85		100...140		020...040		045...100		22...86		112...246		10...30	
	ASC	ASH	ASC	ASH	CMC	CMH	CMC	CMH	KSCM	KSHM	KSCM	KSHM	FMCI/FSC	FMH/FSH
DC40 (b21)	Ambient probe		Ambient probe		Ambient probe		Ambient probe						Ambient probe	
b1	(AS/RS) Remote ambient probe/ Return probe *		(AS/RS) Remote ambient probe/ Return probe *		(AS/RS) Remote ambient probe/ Return probe *		(AS/RS) Remote ambient probe/ Return probe *						(AS/RS) Remote ambient probe/ Return probe *	
b2	(IS1) Indoor coil probe 1		(IS1) Indoor coil probe 1		(IS1) Indoor coil probe 1		(IS1) Indoor coil probe 1						(IS)Indoor coil probe 1	
b3	(TS1) Conden- sing temp. 1	(OS) Outdo- or T ^a probe	(OS) Outdoor T ^a probe		(OS) Outdoor T ^a probe		(OS) Outdoor T ^a probe		(TS1) Outdoor T ^a probe				(OS)Outdoor T ^a probe	
b4	(OS) Outdo- or T ^a probe	(PT1) Conden- sing pressure 1	(PT1) Conden- sing pressure 1	(PT1) Conden- sing pressure 1	(PT1) Conden- sing pressure 1	(PT1) Conden- sing pressure 1	(PT1) Conden- sing pressure 1	(PT1) Conden- sing pressure 1	(PT1) Conden- sing pressure 1	(PT1) Conden- sing pressure 1	(PT1) Conden- sing pressure 1	(PT1) Conden- sing pressure 1	(PT) Conden- sing pressure 1	(PT) Conden- sing pressure 1
b6	(IS2) Indoor coil probe 2		(IS2) Indoor coil probe 2				(IS2) Indoor coil probe 2							
b7	(TS2) Conden- sing temp. 2								(TS2) Conden- sing temp. 2					
b8		(PT2) Conden- sing pressure 2	(PT2) Conden- sing pressure 2	(PT2) Conden- sing pressure 2			(PT2) Conden- sing pressure 2	(PT2) Conden- sing pressure 2	(PT2) Conden- sing pressure 2			(PT2) Conden- sing pressure 2		
INLETS														
ID1	(F7) Thermal protection Indoor fan		(F7) Thermal protection Indoor fan		(F7) Thermal protection Indoor fan		(F7) Thermal protection Indoor fan		(F7) Térmico ventilador interior		(F7) Térmico ventilador interior		(F7) Térmico ventilador interior	
ID2	Cooling/ Heating		Cooling/ Heating		Cooling/ Heating		Cooling/ Heating		Cooling/ Heating		Cooling/ Heating		Cooling/ Heating	
ID3	HIGH PRESSURE circuit 1		HIGH PRESSURE circuit 1		HIGH PRESSURE circuit 1		HIGH PRESSURE circuit 1		HIGH PRESSURE circuit 1		HIGH PRESSURE circuit 1		HIGH PRESSURE circuit 1	
ID4	(LP1) LOW PRESSURE circuit 1		(LP1) LOW PRESSURE circuit 1		(LP1) LOW PRESSURE circuit 1		(LP1) LOW PRESSURE circuit 1		(LP1) LOW PRESSURE circuit 1		(LP1) LOW PRESSURE circuit 1		LOW PRESSURE circuit 1	
ID5	ON / OFF		ON / OFF		ON / OFF		ON / OFF		STEP 1		STEP 1		ON / OFF	
ID6									STEP 2		STEP 2			
ID7									STEP 3		STEP 3			
ID8	HIGH PRESSURE circuit 2		HIGH PRESSURE circuit 2				HIGH PRESSURE circuit 2		HIGH PRESSURE circuit 2		HIGH PRESSURE circuit 2		HIGH PRESSURE circuit 2	
ID9	(LP2) LOW PRESSURE circuit 2		(LP2) LOW PRESSURE circuit 2				(LP2) LOW PRESSURE circuit 2		(LP2) LOW PRESSURE circuit 2		(LP2) LOW PRESSURE circuit 2		(LP2) LOW PRESSURE circuit 2	
ID10									STEP 4		STEP 4			

NOTE: Some probes can change, according to the options selected with the unit.
* Option.

ADVANCED FUNCTIONS

8.- TIMING AND DELAYS

COMPRESSOR

In order to protect compressors from destructively cycling on and off, following protection delays have been set:

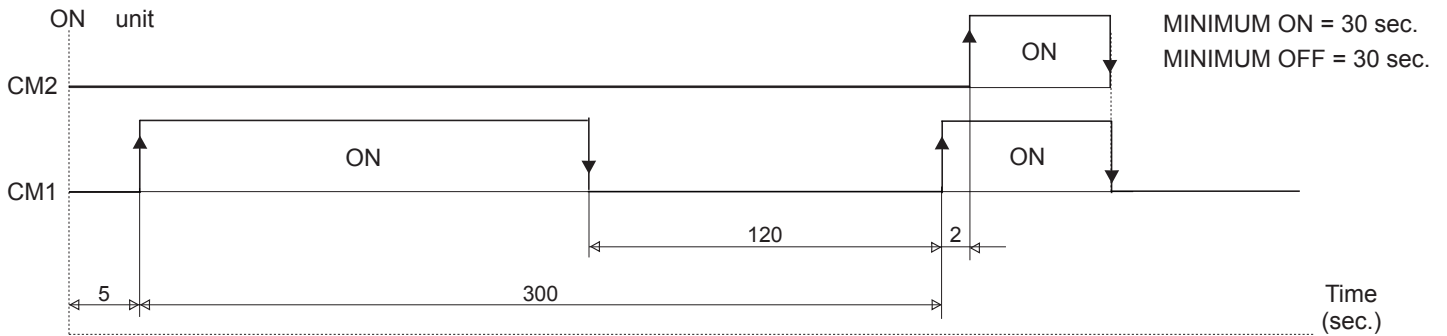

9.- DEFROST

The defrosting process is activated during heating mode in the heat pump units, when the outside temperature is low and the outdoor coil is likely to be frozen. To melt the ice, the defrosting function will switch the unit to cooling operation for a short period. During defrosting mode, the low pressure is at minimum level, so the pressure switch is disabled in this mode. The defrost cycle is illustrated in the following picture.

9.1 - DEFROST CYCLE

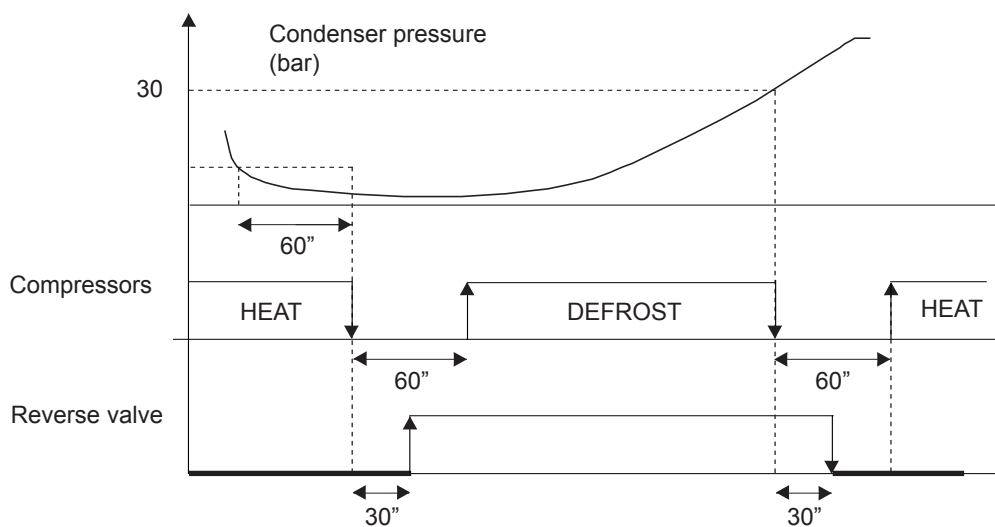

ADVANCED FUNCTIONS

9.2 - DYNAMIC DEFROST

Dynamic defrosting cycle starting (according to outdoor temperature) allows to reduce the number and time of defrosting cycles in winter to achieve better unit efficiency.

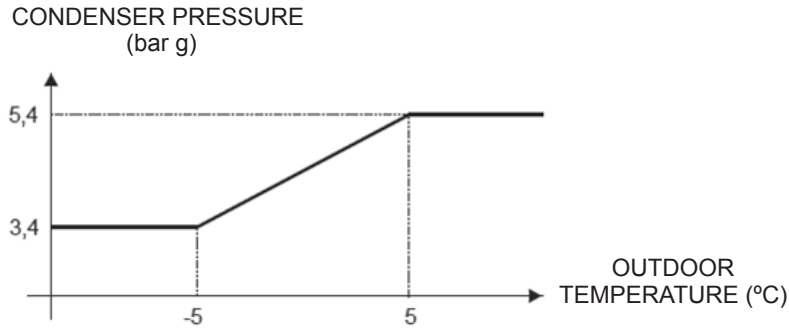

10.- CONDENSER FAN SPEED CONTROL

10.1.- PROPORTIONAL CONTROL BASED ON PRESSURE

Models:

AIRCOOLAIR (ASC + kit -15°C) and (ASHM) 20-85
AIRCUBE (KSCM + kit -15°C) and (KSHM 22E-86D)
(KSCM + kit -15°C 112-214)

FLATAIR (FSC/FMC y FSH/FMH) + kit -15°C
COMPACTAIR (CSC/CMC, CSH/CMH) + kit -15°C
AIRCOOLAIR (ASC+kit -15°C 100-140)

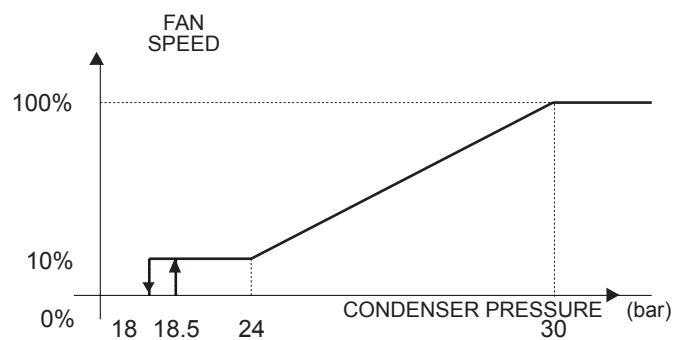
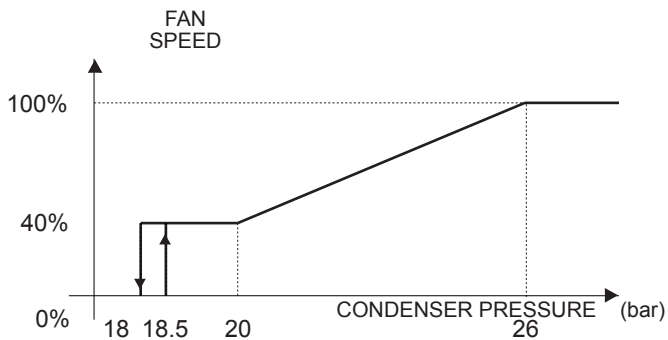

ADVANCED FUNCTIONS

10.2.- PROPORTIONAL CONTROL BASED ON PRESSURE TEMPERATURE

Models: AIRCOOLAIR: ASC 20-85
AIRCUBE: KSCM 22E-86D

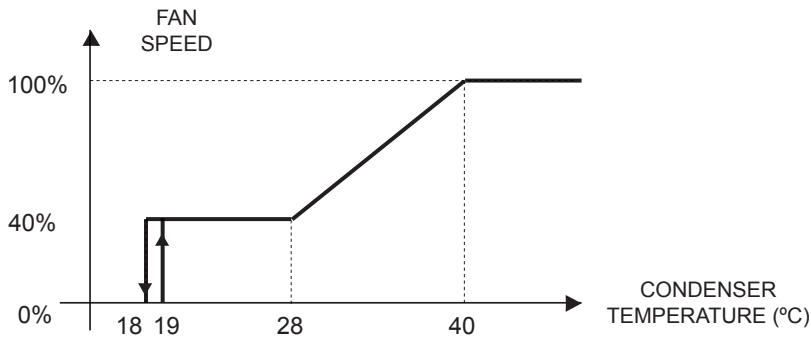

10.3.- ON/OFF CONTROL BASED ON PRESSURE

Models: AIRCOOLAIR: ASC/ASH 100-140
AIRCUBE: KSCM/KSHM 112D-214D

The fans for these models incorporate 2 speeds. The fans work on high or low speed according to:

COOLING MODE:

The on/off and low/high fan speed is managed according to the condensing pressure. See the illustration below:

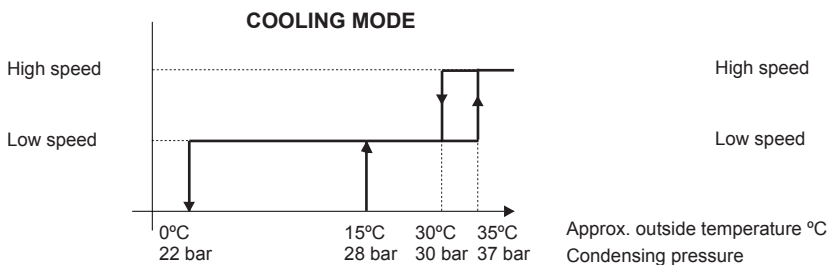

HEATING MODE (heat pump units only). The low/high fan speed

is managed according to the outdoor temperature thermostat. See the illustration below:

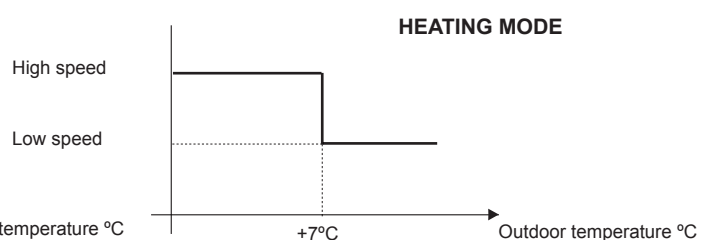

Models: COMPACTAIR: CSC/CMC+kit 0°C CSH/CMH
FLATAIR: FSC/FMC+kit 0°C, FSH/FMH

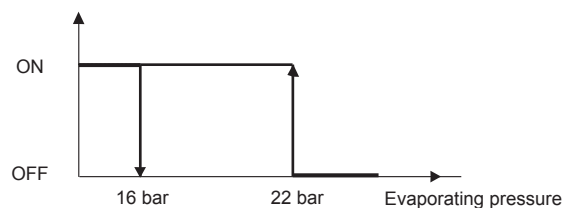
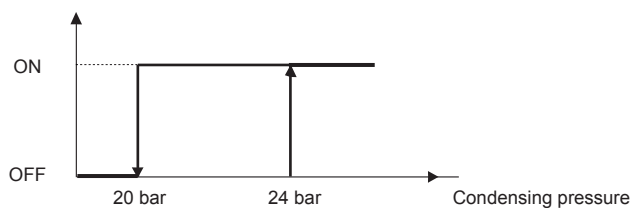

NOTE*: FLATAIR and COMPACTAIR standard models have not included condensing pressure control (fan starts with the compressor), for heat pump units control can be activated with parameter F02=2.

ADVANCED FUNCTIONS

11.- FREE COOLING

OPTION

This option takes advantage of external conditions for cooling mode.

Freecooling is enabled when outdoor temperature is 1°C lower than indoor temperature; when the former is:

- < 10°C, the compressors are deactivated and the air intake gate fully opened in order to refresh with outdoor air only (sufficient under these conditions).

- >10°C, the air intake gate opens and delays the compressors, which turn on only if there would be insufficient outdoor fresh air to achieve the comfort setpoint.

The illustration below shows freecooling regulation.

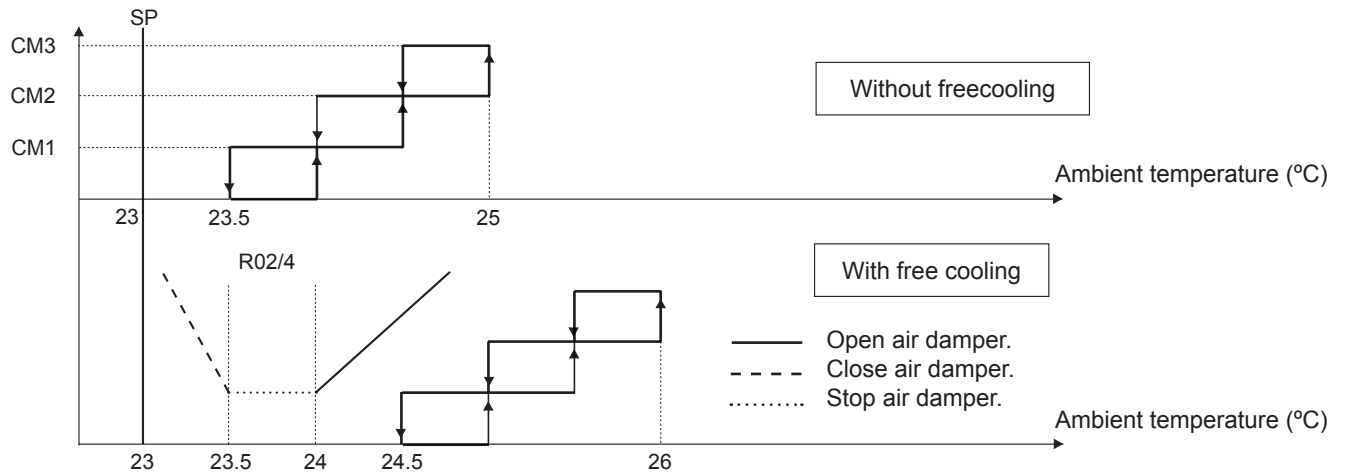

To get a constant air renewal, when freecooling conditions are satisfied, the damper is maintained opened partially (20%), according to the following values.

Par.	DESCRIPTION	Min.	Max.	Def.
r40	This indicates when to carry out the minimum opening of the damper.	0	9	1
	0= Never.			
	1= with freecooling.			
	2= with freeheating.			
	3= with freecooling and freeheating			
	4= always, except with freecooling y freeheating.			
	5= always, except with freeheating.			
	6= always, except with freecooling.			
	7= always			
	8= only for cooling mode.			
	9= only for heating mode.			
r41	% minimum percentage opening damper.	0	100	20

PARAMETERS

PAR.	DESCRIPTION	MIN.	MAX.	VAR.	UD.	BY DEFAULT			
						AIRCOOLAIR	AIRCUBE	COMPACTAIR	FLATAIR 2
Antifreeze and electrical heater									
┌1									
A01	Antifreeze alarm set point.	A7	A4	0.1	°C	2	-----	2	2
A02	Antifreeze differential.	0,3	122	0.1	°C	5	-----	5	5
A03	By-pass time for antifreeze alarm.	0	150	1	sec.	30	-----	30	30
A04	Antifreeze heater set point.	A1	R16	0.1	°C	-----	-----	-----	-----
A05	Antifreeze heater differential.	0,3	50	0.1	°C	-----	-----	-----	-----
A08	Auxiliary heater absolute set point (1 st step).	A1	R16	0.1	°C	-----	-----	-----	-----
	Auxiliary heater relative set point (1 st step).	0	20	0.1	°C	1.5 (ASC) 2,5 (ASH 20-40) 3,5 (ASH 45-85) 4,5 (ASH 100-140)	-----	2,5	2,5
A9	Auxiliary heater differential.	0	20	0.1	°C	1	-----	1	1
A11	Auxiliary heater absolute set point (2 nd step).	A1	R16	0.1	°C	-----	-----	-----	-----
	Auxiliary heater relative set point (1 st step).	0	20	0.1	°C	2.5 (ASC) 3,5(ASH 20-40) 4,5(ASH 45-85)	-----	3,5	3,5
A13	Lower discharge air temperature in freecooling.	A7	R16	0.1	°C	7	-----	7	7
Probes									
b0	Config. of probe to be shown on the display: 0= probe B1. 1= probe B2 2= probe B3. 3= probe B4 4= probe B5. 5= probe B6 6= probe B7. 7= probe B8 8= Set point without compensation. 9= Dynamic set point with possible compensation. 10= Remote ON/OFF digital input status. 11= Terminal DC40 probe.	0	11	1	N	11	10	11	11
b1	Probe B1.	-----	-----	-----	°C				
b2	Probe B2.	-----	-----	-----	°C				
b3	Probe B3.	-----	-----	-----	°C				
b4	Probe B4	-----	-----	-----	°C/bar				
b5	Probe B5.	-----	-----	-----	°C				
b6	Probe B6.	-----	-----	-----	°C				
b7	Probe B7.	-----	-----	-----	°C				
b8	Probe B8.	-----	-----	-----	°C/bar				
b21	Probe DC40.	-----	-----	-----	°C				
Timing and delays									
C01	Min. compressor ON time.	0	999	1	sec.	30	30	30	30
C02	Min. compressor OFF time.	0	999	1	sec.	30	30	30	
C03	Delay between 2 starts of the same compressor.	0	999	1	sec.	300	300	300	300
C04	Delay between starts of the 2 compressor.	0	999	1	sec.	2	2	2	2
C05	Delay between 2 shut-downs of the 2 compressors.	0	999	1	sec.	0	0	0	0
C06	Delay at start up.	0	999	1	sec.	5	5	5	5
C07	Delay in switching on the compressor after switching on the pump.	0	999	1	sec.	2	0	5	5
C08	Delay in switching off the compressor after switching off the pump.	0	150	1	min.	1	0	1	1
C10	Compressor 1 timer.	0	8000	100	hours				
C11	Compressor 2 timer.	0	8000	100	hours				
C12	Compressor 3 timer.	0	8000	100	hours				
C13	Compressor 4 timer.	0	8000	100	hours				
C14	Compressor operation timer threshold (0=not used).	0	100	100	hours	0	0	0	0
C15	Evaporator pump timer.	0	8000	100	hours				
C17	Minimum time between 2 pump starts.	0	150	1	min.	0	0	0	0
C18	Minimum pump/indoor fan ON time.	0	150	1	min.	1	0	1	1
C19						0	0	0	0

PARAMETERS

PAR.	DESCRIPTION	MIN.	MAX.	VAR.	UD.	BY DEFAULT			
						AIRCOOLAIR	AIRCUBE	COMPACTAIR	FLATAIR
Defrost									
d01	Defrosting cycle activation.	0	1	1	flag	1	1	1	1
d03	Start defrosting pressure.	1	D04	0.1	bar	5,4	5,7	5,4	5,4
d04	End defrosting pressure.	D03	/12	0.1	bar	30	30	30	30
d05	Min. time to start a defrosting cycle.	10	150	1	sec.	60	60	60	60
d06	Min. duration of a defrosting cycle.	0	150	1	sec.	0	0	0	0
d07	Max. duration of a defrosting cycle.	1	150	1	min.	8	8	8	8
d08	Delay between 2 defrosting cycle requests with in the same circuit.	10	150	1	min.	35	40	35	35
d09	Defrosting delay between the 2 circuits.	0	150	1	min.	10	10	10	10
Fan									
F02	Fan operating mode: 0= Always ON. 1= Depending on compressor (in parallel operating mode). 2= Depending on compressors in ON/OFF control. 3= Depending on compressors in speed control mode.	0	3	1	int.	1 (ASC 100-140) 2 (ASH 100-140) 3 (ASC/H 20-85)	1 (KSCM 112D-214D) 2 (KSHM 112D-214D) 3 (KSCM/HM 22E-86D)	1	1
F05	Temp. value for min. speed cooling.	-40	176	0.1	°C	28	28	-----	-----
F05	Pressure value for min. speed cooling.	/11	/12	0.1	bar	20 (F2=3) / 22 (F2=2)	20 (F2=3) / 22 (F2=2)	10	10
F06	Differential value for max. speed in cooling mode (temp).	0	50	0.1	°C	12	12	-----	-----
F06	Differential value for max. speed in cooling mode (pres).	0	30	0.1	bar	6	6	3	3
F07	Fan shut-down differential in cooling mode (temp).	0	50	0.1	°C	10	10	-----	-----
F07	Fan shut-down differential in cooling mode (pres).	0	F5	0.1	bar	2	2	2	2
F08	Temperature value for min. speed in heating mode.	-40	176	0.1	°C	30	30	-----	-----
F08	Pressure value for min speed cooling.	/11	/12	0.1	bar	12 (F2=3) / 22 (F2=2)	12 (F2=3) / 22 (F2=2)	22	22
F09	Differential value for max. speed in heating mode (temp).	0	50	0.1	°C	1	1	-----	-----
F09	Differential value for max. speed in heating mode (pres).	0	30	0.1	bar			6	6
F10	Fan shut-down differential in heating mode (temp).	0	50	0.1	°C	0	0	-----	-----
F10	Fan shut-down differential in heating mode (pres).	0	F8	0.1	bar	13	13	13	13
F11	Fan starting time.	0	120	1		0	0	0	0
F15	Activation Low Noise: 0= Deactivate. 1= Activate only in cooling mode. 2= Activate only in heating mode. 3= Activate both in cooling and heating mode.	0	3	1	flag	0	0	0	0
F16	Differential Low Noise in cooling mode.	0	50	0.1	bar	5	5	5	5
F17	Differential Low Noise in heating mode.	0	50	0.1	bar	1	1	1	1
F18	Maximum outdoor temperature with outdoor fan speed regulation (over maximum speed)	-40	176	1	°C	30	30	30	30
Setting									
H06	Activate remote change over: 0= Deactivate. 1= Activate.	0	1	1	flag	0	0 (KSCM) 1 (KSHM)	0	0
H07	ON/OFF remoto: 0= Deactivate. 1= Activate.	0	1	1	flag	1	1	1	1
H10	Serial address.	1	200	1	ud.	1	1	1	1
H23	Activate Modbus.	0	1	1	flag	0	0	0	0
H97	Expansion board software version.	0	999	1	flag				
H99	Software version.	0	999	1	flag				
Alarms									
P04	Enable part load in high pressure: 0= Capacity control desactivated 1= Capacity control activated for high pressure. 2=Capacity control activated for low pressure. 3= Capacity control activated for high and low pres.	0	3	1	flag	1	1	1	1
P09	Configuration for digital input: 0= Not configured 10= winter/summer operation (PSW 66)	0	23	1	ud	0	0	0	0

PARAMETERS

PAR.	DESCRIPTION	MIN.	MAX.	VAR.	UD.	BY DEFAULT			
						AIRCOOLAIR	AIRCUBE	COMPACTAIR	FLATAIR 2
Regulation									
r1	Cooling set point.	R13	R14	0.1	°C	20	-----	20	20
r2	Differential in cooling mode.	0.3	50	0.1	°C	1 (ASC/ASH 20-40) 2 (ASC/ASH 45-85) 3 (ASC/ASH 100-140)	-----	1 (CMC/H 20-40) 2 (CMC/H 45-85) 3 (CMC/H 100)	1
r3	Heating set point.	R15	R16	0.1	°C	25	-----	25	25
r4	Differential in heating mode.	0.3	50	0.1	°C	1 (ASH 20-40) 2 (ASH 45-85) 3 (ASH 100-140)	-----	1 (CMC/H 20-40) 2 (CMC/H 45-85) 3 (CMC/H 100)	1
r7	Dead zone.	1	50	0.1	°C	0.5	-----	0,5	0,5
r17	Cooling compensation constant.	-5	5	0.1	-----	0	-----	0	0
r18	Maximum distance from the set point.	0.3	20	0.1	°C	2	-----	2	2
r19	Start compensation temperature in cooling mode.	-40	176	0.1	°C	35	-----	35	35
r20	Start compensation temperature in heating mode.	-40	176	0.1	°C	6	-----	6	6
r21	Second cooling set point.	R13	R14	0.1	°C	28	-----	28	28
r22	Second heating set point.	R15	R16	0.1	°C	18	-----	18	18
r23	Select automatic change over probe.	0	8	1	flag	0	-----	0	0
r24	Automatic change over set point.	R15	R16	0.1	°C	23	-----	23	23
r25	Outside temp. set point to stop compressors.	-40	80	0.1	°C	-15	-15	-15	-15
r31	Heating compensation constant.	-5	5	0.1	-----	0	0	0	0
Clock									
t01	Real Time Clock (RTC) hours.	0	23	1	-----				
t02	Real Time Clock (RTC) minutes.	0	59	1	-----				
t03	Real Time Clock (RTC) days.	1	31	1	-----				
t04	Real Time Clock (RTC) month.	1	12	1	-----				
t05	Real Time Clock (RTC) years.	0	99	1	-----				
t06	Start hours for 2 nd set point in cooling.	0	23	1	-----	0	0		
t07	Start minutes for 2 nd set point in cooling.	0	59	1	-----	0	0		
t08	End hours for 2 nd set point in cooling.	0	23	1	-----	0	0		
t09	End minutes for 2 nd set point in cooling.	0	59	1	-----	0	0		
t10	Start hours for 2 nd set point in heating.	0	23	1	-----	0	0		
t11	Start minutes for 2 nd set point in heating.	0	59	1	-----	0	0		
t12	End hours for 2 nd set point in heating.	0	23	1	-----	0	0		
t13	End minutes for 2 nd set point in heating.	0	59	1	-----	0	0		
t14	Start hours for 2 nd low noise cooling.	0	23	1	-----	0	0		
t15	Start minutes for 2 nd low noise in cooling.	0	59	1	-----	0	0		
t16	End hours for 2 nd low noise in cooling.	0	23	1	-----	0	0		
t17	End minutes for 2 nd low noise in cooling.	0	59	1	-----	0	0		
t18	Start hours for 2 nd low noise in heating.	0	23	1	-----	0	0		
t19	Start minutes for 2 nd low noise in heating.	0	59	1	-----	0	0		
t20	End hours for 2 nd low noise in heating.	0	23	1	-----	0	0		
t21	End minutes for 2 nd low noise in heating.	0	59	1	-----	0	0		



WARNING

Default values could vary depending on optional kits or improvements.

ANTIFREEZE PROTECTION (AIRCOOLAIR / COMPACTAIR / FLATAIR).

The unit is protected by means of a temperature probe located in the indoor piping, when the indoor temperature goes drops 2°C:
WITHOUT FREECOOLING

- The compressors shut down and the antifreeze alarm goes on.
- The alarm is reset automatically when the temperature reaches 7°C.

WITH FREECOOLING

- Air intake gate closes,
- Once the gate is completely closed, the compressors shut down and the antifreeze alarm goes on.

When the air intake gate is closing, if the temperature in the indoor piping goes up 2°C, the gate stops and stays in the position reached; then, if the temperature reaches goes over 7°C, the air damper starts to open or, if the temperature goes down 2°C, the damper start to close again.

In addition to that, in order to prevent frozen air discharging when freecooling without the compressors working (outdoor temp. <10°C), if the temperature in the indoor piping goes down 7°C, the air intake gate starts to mix outdoor air with return air, thus increasing the temperature of the discharge air.

ASSEMBLY AND INSTALLATION INSTRUCTIONS

DC40.

Installation instructions

1. Separate the cover of the instrument from the bodypart using a screwdriver as shown in Fig. 8.1.
2. Open the instrument with a “hinge” movement, pivoting the cover of the instrument upwards.

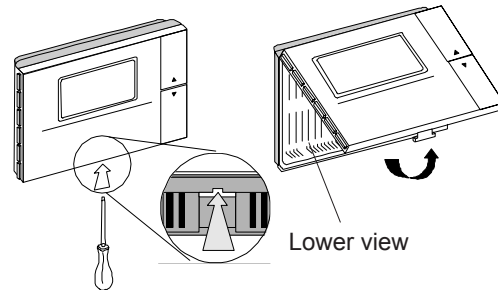

Fig. 8.1

3. Fix the rear part to the wall, taking care that the connection cables pass through the hole in the centre of the rear casing. The distances between the fastening holes are designed so as to be able to fit the DC40 to a flush-mounting connection box compliant with the CEI C.431 - IEC 670 standards. If this is not available, use the fastening holes on the casing as a guide for drilling the holes in the wall, and then use the kit of screws and plugs supplied.
4. Connect the cables to the terminals located in the casing as indicated in the casing itself or in the electrical diagram.

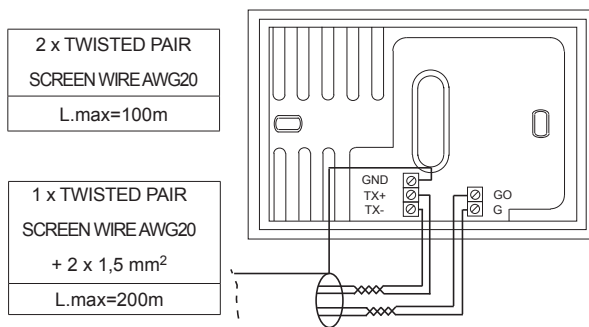

Fig. 8.2



Keep the DC40's inductive load cables separate from those of any power devices (contactors, etc.) in order to prevent electromagnetic interference.
Do not lay power and communications cables together

- Run a connection from the electrical box in the outdoor unit to the DC40 device:

- . 91 and 92 terminal blocks respectively to Tx+ and Tx- (Twisted pair for communications).
- . 93 and 94 terminal blocks respectively to GO and G. (Twisted pair for 24VAC power).
- . 90 to GND. (shield).

5. Once the installation is complete, fit the terminal onto the casing by pivoting the cover with a “hinge” movement and close it. When closing, make sure that the pins on the board fit into the corresponding terminals.

Installation warnings

- Disconnect the power supply before working on the DC40 during operations of assembly, maintenance and replacement.
- The terminal must be fastened to the wall in such a way as to allow the circulation of air through the slits on the rear casing.
- Avoid installing the boards in environments with the following characteristics:
 - Avoid locations where there is a great variation in room temperature.
 - Near doors leading to the outside.
 - On outside walls.
 - Where it will be exposed to direct sunlight or to conditioned air flow.
 - Where there are strong magnetic and/or radio frequency interference (for example, near transmitting antennae).

ALARMS

ALARMS/WARNINGS DISPLAY

The unit self-protects by means of safety devices; when any of these safety devices detects an anomaly, this is shown on the Climatic 40 display and, in Aircoolair / Compactair / Flatair units only, also on the DC41 display (even if it has a different alarm code), in order to warn the operator.

Depending on the type of anomaly, Climatic 40 shows:

- Alarm. Serious anomaly. This is one that has a direct effect on the operation of the unit.
- Warning. Non-serious anomaly. This is one that has no direct effect on the operation of the unit.

The activation of an alarm results in:

- Alarm code being shown on BM40 display alternately with the main menu.
- in Aircoolair / Compactair / Flatair units, an alarm code (different from the one for the Climatic 40) being shown on the DC40 display alternately with the main menu.
- A red bell appears on the Climatic 40 display and the alarm relay is activated. (contacts 99-100).
- In some cases, depending on the type of alarm, some of the outputs may be blocked, thus stopping the unit.

The activation of a warning results in:

- A warning code being shown only on the Climatic 40 display, alternately with the main menu.

ALARM/WARNING RESET

Some alarms are reset automatically. When the cause is no longer present, they disappear from the display.

Others alarms are reset manually and, once the alarm conditions have disappeared, they need to be reset by the user as shown below:

CLIMATIC BM40



5 Sec.

DC 40

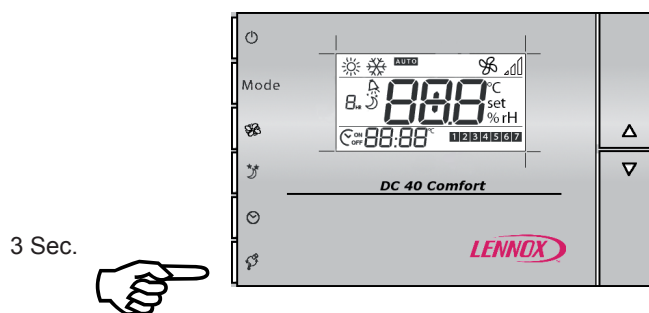

3 Sec.

ALARMS

ALARMS/WARNINGS CODES

DISP CL40/ DC41	DISP DC40	DESCRIPTION	EFFECT	RE	ACTION
HP1	HP	High pressure switch alarm, circuit 1. This alarm may indicate the following problems: - High pressure switch protection. - Compressor stopped. - Excessive refrigerant charge.	Circuit 1 compressors stop	AUTO/ MAN. After 3 times in 1 hour	Reset and check: - Coil is clean and not blocked. - Outdoor fan during cooling cycle. - Indoor fan during heating cycle. - Compressor protection. - Condenser air temperature is very high. - Refrigerant charge.
HP2		High pressure switch alarm, circuit 2. The same as previous alarm but this time referring to circuit 2.	Circuit 2 compressors stop	AUTO/ MAN. After 3/h	The same as previous alarm but this time referring to circuit 2.
LP1	LP	Low pressure switch alarm, circuit 1. This alarm may indicate the following problems: - Low refrigerant. - Outdoor fan stopped. - Low pressure switch protection.	Circuit 1 compressors stop	AUTO/ MAN. After 3 times in 1 hour	Reset and check: - Coil is clean and not blocked. - Outdoor fan during heating cycle. - Indoor fan during cooling cycle. - Fuses of the fan. - Evaporation air temperature is very low. - Check refrigerant charge. - Expansion valve.
LP2		Low pressure switch alarm, circuit 2. The same as previous alarm but this time referring to circuit 2.	Circuit 2 compressors stop	AUTO/ MAN. After 3/h	The same as previous alarm but this time referring to circuit 2.
TP	T	Indoor fan thermal protection alarm: - Fan thermal protection open. - Faulty power supply.	Unit stops	MAN.	Reset and check: - Fan. - Power supply.
TC1		Not used.	-----	-----	Call Technical Service.
TC2		Not used.	-----	-----	Call Technical Service.
LA	-----	Not used.	-----	-----	Call Technical Service.
FLb	-----	Not used.	-----	-----	Call Technical Service.
E1	E00	B1 probe error. Faulty probe or connection.	Unit stops	AUTO	Check connection of B1 probe (see electrical diagram), check continuity and change the faulty component.
E2		B2 probe error. Faulty probe or connection.	Unit stops	AUTO	Check connection of B2 probe (see electrical diagram), check continuity and change the faulty component.
E3		B3 probe error. Faulty probe or connection.	Unit stops	AUTO	Check connection of B3 probe (see electrical diagram), check continuity and change the faulty component.
E4		B4 probe/pressure transducer error. Faulty probe or connection.	Unit stops	AUTO	Check connection of B4 probe/pressure transducer (see electrical diagram), check continuity and change the faulty component.
E5		Not used.	-----	-----	Call Technical Service.
E6		B6 probe error. Faulty probe or connection.	Unit stops	AUTO	Check connection of B6 probe(see electrical diagram), check continuity and change the faulty component.
E7		B7 probe error. Faulty probe or connection.	Unit stops	AUTO	Check connection of B7 probe (see electrical diagram), check continuity and change the faulty component.
E8		B8 probe/pressure transducer error. Faulty probe or connection.	Unit stops	AUTO	Check connection of B8 probe/pressure transducer (see electrical diagram), check continuity and change the faulty component.
Hcl-4	Hc	Warning. Compressor operating time limit exceeded. Disabled by default.	-----	AUTO	Check: - Compressor operating time (parameter C10). - Compressor operating time limit (par. C15).
HF1	-----	Warning. Indoor fan operating time limit exceeded. Disabled by default.	-----	AUTO	Check: - Indoor fan operating time (parameter C15). - Indoor fan operating time limit (par. C15).
EPr	-----	Warning. Climatic 40 hardware error.	-----	AUTO	Call Technical Service.
Epb	-----	Warning. Climatic 40 hardware error.	Unit stops	AUTO	Call Technical Service.
ESP	ESP	Expansion board error.	Unit stops	AUTO	Check: - Green LED is on inside the board. - J4-J9 connections (see electrical diagram). Call Technical Service.
EL1-2	-----	Warning. Condensing fan speed control hardware error.	Outdoor fan at maximum speed.	AUTO	- Check CFM board connections (see electrical diagram). Call Technical Service.
dF1-2	-----	Warning. Circuit 1-2 defrost ends due to maximum time (8 minutes).	-----	AUTO	

ALARMS

ALARMS/WARNINGS CODES

DISP CL40/ DC41	DISP DC40	DESCRIPTION	EFFECT	RE	ACTION
A1	A12	Antifreeze alarm. - AIRCOOLAIR / COMPACTAIR / FLATAIR circuit 1 indoor piping temperature < 2°C. Reset AUTO.	Close freecooling air dumper and stops circuit 1 compressors 1	MAN/ AUTO	Check: - Indoor unit air filter. - Air damper working correctly.
A2		Antifreeze alarm, circuit 2. (Aircoolair, Compactair, Flatnair). Circuit 2 indoor piping temperature < 2°C. Reset AUTO.	Close freecooling air dumper and stops circuit 1 compressors 2	AUTO	Check: - Indoor unit air filter. - Air damper working correctly.
Ht	-----	High ambient temperature warning. Ambient temperature > 40°C.	-----	AUTO	Check location of ambient probe; avoid places where measurement of the ambient temperature by the internal may be altered.
Lt	-----	Warning the low ambient temperature. Disabled by default.	-----	-----	Call Technical Service.
AHt	-----	Not used.	-----	-----	Call Technical Service.
HLt	-----	Not used.	-----	-----	Call Technical Service.
ELS	-----	Low power supply warning. Power supply < 20.4V.	-----	AUTO	Check power supply of controller = 24V (see electrical diagram).
EHS	-----	High power supply warning. Power supply > 26.4V.	Unit stops	AUTO	Check power supply of controller = 24V (see electrical diagram).
Ed1	-----	Not used.	-----	-----	Call Technical Service.
Ed2	-----	Not used.	-----	-----	Call Technical Service.
SH1	-----	Not used.	-----	-----	Call Technical Service.
SH2	-----	Not used.	-----	-----	Call Technical Service.
nO1	-----	Not used.	-----	-----	Call Technical Service.
nO2	-----	Not used.	-----	-----	Call Technical Service.
LO1	-----	Not used.	-----	-----	Call Technical Service.
LO2	-----	Not used.	-----	-----	Call Technical Service.
HA1	-----	Not used.	-----	-----	Call Technical Service.
HA2	-----	Not used.	-----	-----	Call Technical Service.
EP1	-----	Not used.	-----	-----	Call Technical Service.
EP2	-----	Not used.	-----	-----	Call Technical Service.
ES1	-----	Not used.	-----	-----	Call Technical Service.
ES2	-----	Not used.	-----	-----	Call Technical Service.
EU1	-----	Not used.	-----	-----	Call Technical Service.
EU3	-----	Not used.	-----	-----	Call Technical Service.
Eb1	-----	Not used.	-----	-----	Call Technical Service.
Eb2	-----	Not used.	-----	-----	Call Technical Service.
L	-----	Not used.	-----	-----	Call Technical Service.
Ed1	-----	Not used.	-----	-----	Call Technical Service.
Ed2	-----	Not used.	-----	-----	Call Technical Service.
PH1	-----	Not used.	-----	-----	Call Technical Service.
PH2	-----	Not used.	-----	-----	Call Technical Service.
SUL	-----	Not used.	-----	-----	Call Technical Service.
tEr	OcH	Alarm, faulty communication between DC40 and Climatic 40. (AIRCOOLAIR/COMPACTAIR/FLATAIR)	Unit stops	AUTO	- DC40 connections (see electrical diagrams). Call Technical Service.
	AcH	Generic alarm. Some active alarms on Climatic 40.	-----	-----	Check Climatic 40 alarm code and act by accordingly.
	Ahu	Not used.	-----	-----	Call Technical Service.
	AtE	DC40 internal probe alarm. Faulty internal probe.	-----	-----	Call Technical Service.
	CEr	DC40 setting error.	-----	-----	Call Technical Service.
	UEr	DC40 hardware error.	-----	-----	Call Technical Service.

ALARMS

ALARM LOG

The Climatic 40 has a log where significant events that stop (alarms) or limit (warnings) the operation of the unit are saved. In order to enter the Alarm Log menu, proceed as explained in chapter 3 *MENU* in the paragraph *PARAMETERS EDITING MENU*, entering the password 44 instead of 22.

Up to 25 events can be saved, highlighting in order: event code, start hours, start minutes, start day, start month, end hours, end minutes, end day, end month.

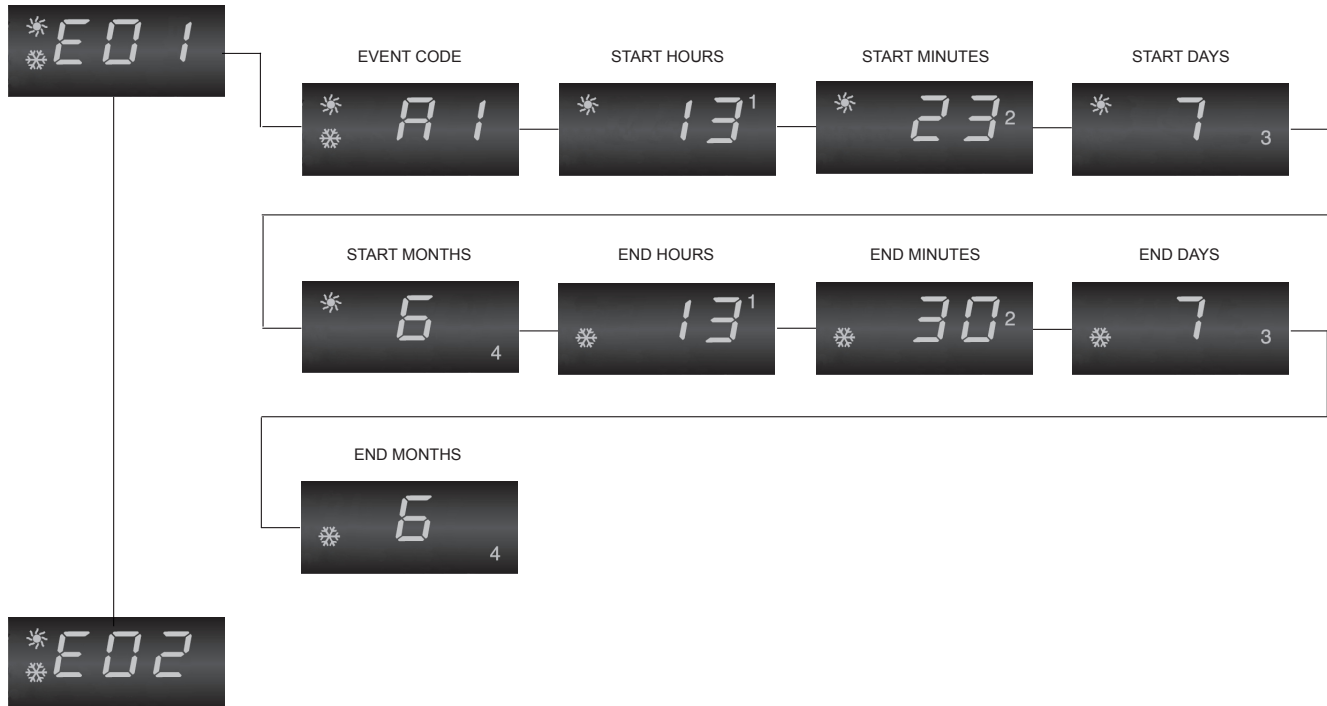

WARNING

The alarm log is active and operative only if the clock board is fitted.
If there are no alarms saved, "noH" is displayed.

NOTES



www.lennox europe.com

BELGIUM, LUXEMBOURG
www.lennoxbelgium.com

CZECH REPUBLIC
www.lennox.cz

FRANCE
www.lennoxfrance.com

GERMANY
www.lennoxdeutschland.com

GREAT BRITAIN
www.lennoxuk.com

NETHERLANDS
www.lennoxnederland.com

POLAND
www.lennoxpolska.com

PORTUGAL
www.lennoxportugal.com

RUSSIA
www.lennoxrussia.com

SLOVAKIA
www.lennoxdistribution.com

SPAIN
www.lennoxspain.com

UKRAINE
www.lennoxrussia.com

OTHER COUNTRIES
www.lennoxdistribution.com

Due to Lennox's ongoing commitment to quality, the Specifications, Ratings and Dimensions are subject to change without notice and without incurring liability.

Improper installation, adjustment, alteration, service or maintenance can cause property damage or personal injury.

Installation and service must be performed by a qualified installer and servicing agency.

